

| REV. | REVISION RECORD | BY  | DATE      |
|------|-----------------|-----|-----------|
| 0    | ORIGIN          | LDJ | 4.15.2026 |

CUSTOMER'S MODEL: NO MODEL  
END COVER COLOR: BLACK

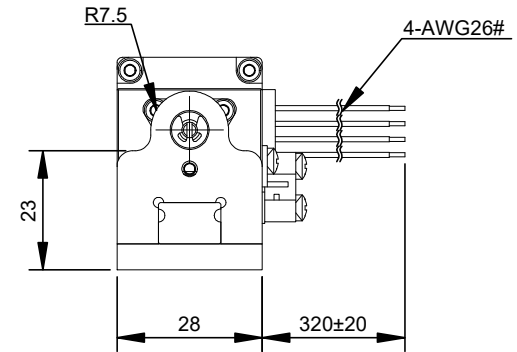
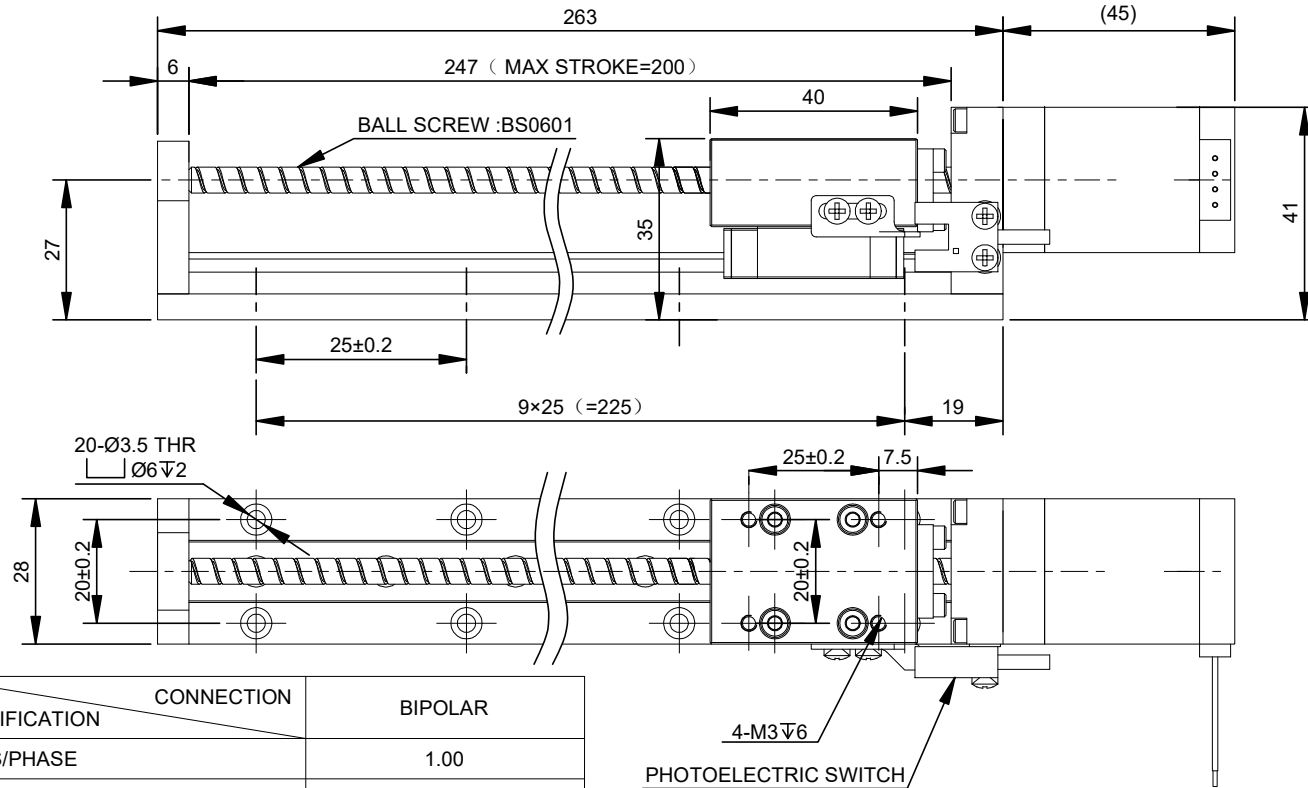

| PHOTOELECTRIC SWITCH SEQUENCE |             |       |
|-------------------------------|-------------|-------|
| PIN NO                        | BIPOLAR     | LEADS |
| 1                             | +5~24V      | BRN   |
| 2                             | GND         | BLU   |
| 3                             | SIGNAL LINE | BLK   |
| 4                             | N/A         | WHT   |

| SPECIFICATION               | CONNECTION | BIPOLAR                |
|-----------------------------|------------|------------------------|
| AMPS/PHASE                  |            | 1.00                   |
| RESISTANCE/PHASE(Ohms)@25°C |            | 3.70±10%               |
| INDUCTANCE/PHASE(mH)@1KHz   |            | 2.30±20%               |
| HOLDING TORQUE(Nm)[lb-in]   |            | 0.10[0.88]             |
| MAXIMUM THRUST(N)           |            | 150                    |
| STEP ANGLE(°)               |            | 1.80                   |
| STEP ACCURACY(NON-ACCUM)    |            | ±5.00%                 |
| LEAD(mm)[in]                |            | 1[0.0393]              |
| LINEAR TRAVEL/STEP(mm)[in]  |            | 0.005[0.00019685]      |
| RATED LOAD CAPACITY(N)      |            | 130                    |
| MAX SPEED(mm/s)             |            | 30                     |
| POSITION ACCURACY(mm)       |            | ±0.02                  |
| AMBIENT TEMPERATURE         |            | -20°C~50°C[-4°F~122°F] |
| INSULATION CLASS            |            | B 130°C[266°F]         |
| TEMPERATURE RISE            |            | MAX.80°C               |

COMMENT:  
1.TMBF 6000h OR MORE @ 24V/300RPM  
2.INSULATION RESISTANCE  
(NORMAL TEMPERATURE AND HUMIDITY): 100 Mohm  
3.DIELECTRIC STRENGTH 500VAC FOR 1MIN.  
(BETWEEN THE MOTOR COILS AND THE MOTOR CASE )

| MOTOR CONNECTION |         |         |         |
|------------------|---------|---------|---------|
| PIN NO           | BIPOLAR | LEADS   | WINDING |
| 1                | A+      | RED     |         |
| 2                | A-      | RED/WHT |         |
| 3                | B+      | GRN     |         |
| 4                | B-      | GRN/WHT |         |

| FULL STEP 2 PHASE-Ex.,WHEN FACING MOUNTING END (X) |    |    |    |    | CCW | CW | DIMENSIONS ARE IN MILLIMETERS.<br>TOLERANCES AS BELOW:<br>DECIMALS ANGLES<br>X ±0.5 ±2°<br>X.X ±0.25<br>X.XX ±0.13 |
|--|----|----|----|----|-----|----|--|
| STEP   | A+ | B+ | A- | B- |     |    |  |
| 1  | +  | +  | -  | -  |     |    |  |
| 2  | -  | +  | +  | -  |     |    |  |
| 3  | -  | -  | +  | +  |     |    |  |
| 4  | +  | -  | -  | +  |     |    |  |

THIS DOCUMENT SHALL NOT BE REPRODUCED NOR SHALL THE INFORMATION CONTAINED HEREIN BE USED BY OR DISCLOSED TO OTHERS UNLESS EXPRESSLY AUTHORIZED IN BY WRITING STEPPERONLINE.

| SIGNATURE |     | DATE      |
|-----------|-----|-----------|
| DRN       | LDJ | 4.15.2026 |
| APVD      | LJ  | 4.15.2026 |

**STEPPERONLINE®**

LINEAR ACTUATORS

LMD11S18BSM10-200