

REV.	REVISION RECORD	BY	DATE
0	ORIGIN	LDJ	4.15.2026

CUSTOMER'S MODEL: NO MODEL
 END COVER COLOR: BLACK

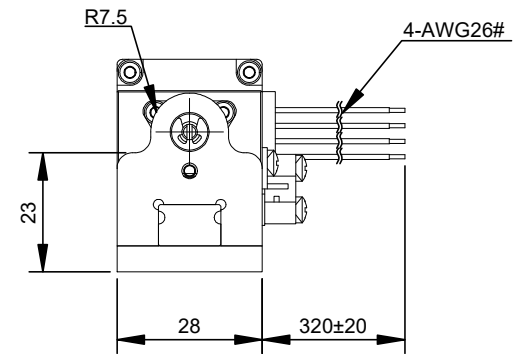
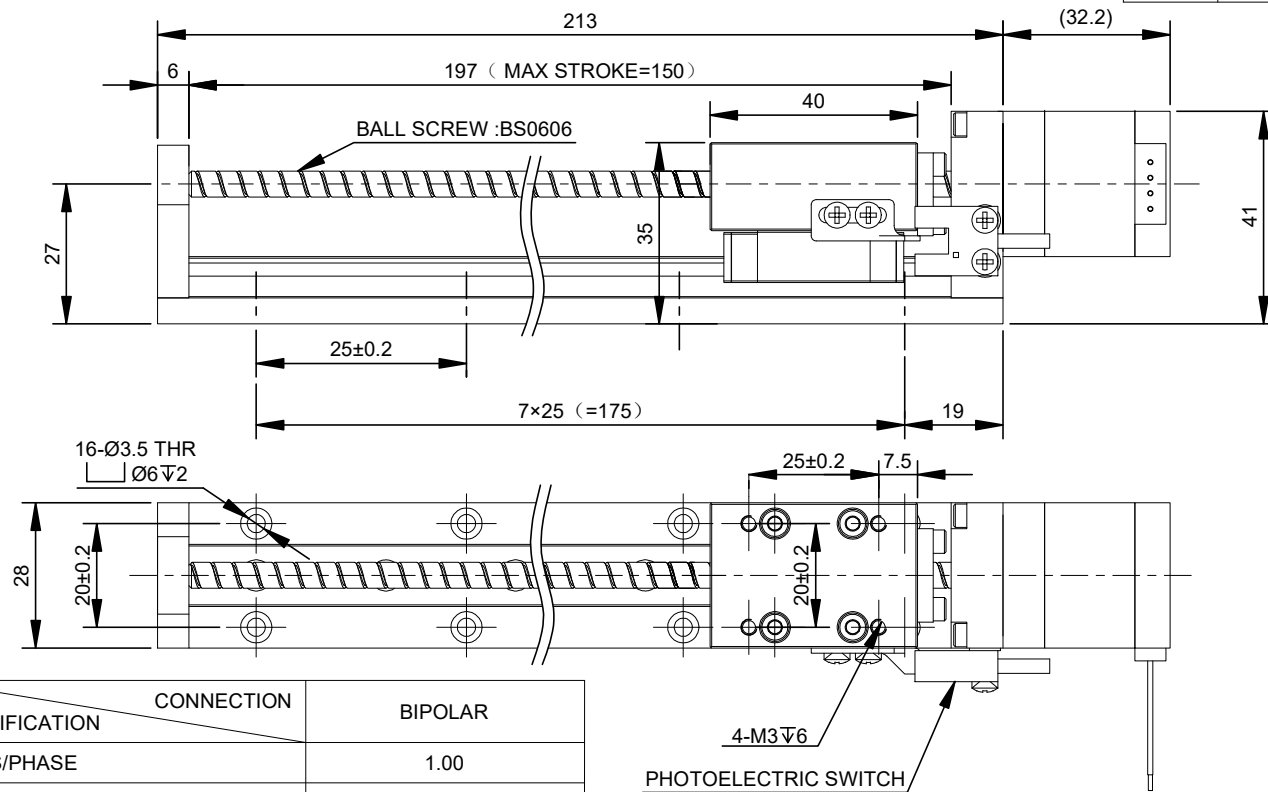

PHOTOELECTRIC SWITCH SEQUENCE		
PIN NO	BIPOLAR	LEADS
1	+5~24V	BRN
2	GND	BLU
3	SIGNAL LINE	BLK
4	N/A	WHT

SPECIFICATION	CONNECTION	BIPOLAR
AMPS/PHASE		1.00
RESISTANCE/PHASE(Ohms)@25°C		2.50±10%
INDUCTANCE/PHASE(mH)@1KHz		1.50±20%
HOLDING TORQUE(Nm)[lb-in]		0.05[0.44]
MAXIMUM THRUST(N)		18
STEP ANGLE(°)		1.80
STEP ACCURACY(NON-ACCUM)		±5.00%
LEAD(mm)[in]		6[0.2362]
LINEAR TRAVEL/STEP(mm)[in]		0.03[0.0011811]
RATED LOAD CAPACITY(N)		12
MAX SPEED(mm/s)		90
POSITION ACCURACY(mm)		±0.02
AMBIENT TEMPERATURE		-20°C~50°C[-4°F~122°F]
INSULATION CLASS		B 130°C[266°F]
TEMPERATURE RISE		MAX.80°C

COMMENT:
 1.TMBF 6000h OR MORE @ 24V/300RPM
 2.INSULATION RESISTANCE
 (NORMAL TEMPERATURE AND HUMIDITY): 100 Mohm
 3.DIELECTRIC STRENGTH 500VAC FOR 1MIN.
 (BETWEEN THE MOTOR COILS AND THE MOTOR CASE)

MOTOR CONNECTION			
PIN NO	BIPOLAR	LEADS	WINDING
1	A+	RED	
2	A-	RED/WHT	
3	B+	GRN	
4	B-	GRN/WHT	

FULL STEP 2 PHASE-Ex.,WHEN FACING MOUNTING END (X)					CCW	CW	DIMENSIONS ARE IN MILLIMETERS. TOLERANCES AS BELOW: DECIMALS ANGLES X ±0.5 ±2° X.X ±0.25 X.XX ±0.13
STEP	A+	B+	A-	B-			
1	+	+	-	-			
2	-	+	+	-			
3	-	-	+	+			
4	+	-	-	+			

STEPPERONLINE®

LINEAR ACTUATORS

LMD11S13BUM10-150

THIS DOCUMENT SHALL NOT BE REPRODUCED NOR SHALL THE INFORMATION CONTAINED HEREIN BE USED BY OR DISCLOSED TO OTHERS UNLESS EXPRESSLY AUTHORIZED IN BY WRITING STEPPERONLINE.

SIGNATURE		DATE
DRN	LDJ	4.15.2026
APVD	LJ	4.15.2026